

MODELLING OF REMOTE AREA BROADBAND TECHNOLOGY OVER LOW VOLTAGE POWER LINE CHANNEL

Abdallah Mahmoud Mousa Altrad¹, Wan Rozaini Sheik Osman² and
Kashif Nisar³

¹School of Computing and ITU-UUM, Asia Pacific Centre of Excellence for Rural ICT
Development

00610, UUM, Sintok, Kedah, Malaysia
aaltrad@yahoo.com

²School of Computing and ITU-UUM, Asia Pacific Centre of Excellence for Rural ICT
Development_ rozai174@uum.edu.my

³School of Computing and ITU-UUM, Asia Pacific Centre of Excellence for Rural ICT
Development_ Kashif@uum.edu.my

ABSTRACT

Several broadband development initiatives have been proposed in Malaysia in order to Bridging Digital Divide (BDD) through the provisions of the Information and Communication Technology (ICT) services to facilitate wide access to the internet through corporates government and private sector for high level of scio-economy. Nevertheless, there is delay in provide broadband services due to the high cost of deployment in the remote area. Therefore, this paper investigates on Broadband over Power Lines (BPL) technology and Malaysia's broadband initiatives. BPL transmission technology model of using electrical power lines for data, video and voice transmission is proposed. Furthermore, indoor part of the proposed model is carried out on Matlab/Simulink to explore the validity of power line channel transfer function.

KEYWORDS

BPL, BDD, PLC, ICT Rural Area.

1. INTRODUCTION

Broadband is considered as a data communication technology providing a permanent high throughput connection. Both Broadband and ICT connections are significantly contributing to the provision of public services in Malaysia. On the other hand, ICT is considered as a varying set of technological tools and resources utilized for the creation, storage, management and communication of information for purposes such as education, communication and business [1]. So ICT could help increase prosperity of any willing community, ensure technology infrastructure and training people to become scio-economy.

The current demand for high capacity broadband is appeared by the always-on services like video-conferencing, high definition video streaming and interactive gaming [2]. Although broadband access is provided by passive optical networks (PON) and DSL technologies in rural areas, the high cost of network deployment in these places has resulted in delays of broadband roll out. Varying factors impact rural broadband access namely, services, infrastructure, demography and topology [3]. The thing in Malaysia which is clearly observed that, it has an annoying fact regarding broadband deployment in all rural remote areas due to geographical dispersion of population, hilly terrain at some places, dense trees area and difficulties to acquire suitable sites for even wireless solution and the rural areas are often remote and lower income levels.

The Malaysian government has introduced the BDD program with the help of telecenters in the earlier parts of 2000 as an attempt to increase ICT access and use in rural communities and minority groups in the country [4]. The rationale behind the setting up of telecenters is to provide and reinforce ICE usage and to develop a community communication set up with a variety of ICT services for Internet access, e-commerce and e-learning [5]. Moreover, the Malaysian Public Sector ICT Strategic Plan (2011-2015) lays down the guidelines to be followed in the attempts to accelerate the innovative use and development of ICT [6].

Based on the report regarding Broadband Growth and Policies in Malaysia 2010, Malaysia has developed a competitive industry and achieved high diffusion rate for communication services in an environment of open economy and thus, the country continues its emphasis on innovation in technology and ICT, which includes generation of related services on the basis of an effective foundation of broadband connectivity which in turn results in encouraging new areas of development. The attempt at encouraging broadband uses in Malaysian households shows progress and has exceeded the goal of 50% in 2010 and is currently developing towards the next target of 75% by 2012.

The 2010 target of 50% broadband penetration was brought about through the High Speed Broadband (HSBB) initiative which is stated in Malaysia's National Broadband Implementation Strategy and is a part of the government strategy. The increasing emphasis on high-tech and knowledge based industries imply that broadband would become a crucial tool for industries and households. Similar to electricity and water supply which are main necessities of households, broadband can deliver great advantages to Malaysia and their target of 50% by 2010 may contribute to the country's GDP by 1% and facilitate the creation of 135, 000 new high value jobs by 2010. Moreover, it may create opportunities and markets for developers of applications and content [6].

Broadband to the General Population (BBGP) is considered as the second level in the supply push and its deployment is planned in every area including areas encompassed by HSBB. It will be facilitated through current licensees utilizing fixed Asynchronous Digital Subscriber Line (ADSL), wireless High-Speed Packet Access (HSPA) or Wireless Interoperability for Microwave Access (WiMAX). These technologies offer alternative means of broadband access [7]. However, in the current time, broadband is much too costly for specific social segments of the country which are unable to obtain broadband subscriptions, modems and access devices. The government is planning to take up a three branched strategy in three main areas for demand creation.

1. First, to let the public be aware of the broadband benefits and availability.
2. Second, to develop the broadband attractiveness in light of its good content and applications, and
3. Third, to offer reasonable broadband prices.

The access to computers in strategic places like libraries, telecenters, cybercafés etc. may positively impact the social and economic development if it is steered to meet the needs of the marginalized population where the services are not free of charge [8]. Thus, Malaysia's broadband market is still considered in its earlier phases with only 55% of households are using broadband [9].

For the purpose of providing high transmission rate, many trail projects have been tested over time in many countries to result in new broadband technology increasing household internet access. Consequently, successful projects have been implemented and have facilitated the transmission over power lines including Broadband over Power Lines (BPL), Power Lines Communication (PLC), Digital Power Line (DPL) or Power Lines Transmission (PLT). BPL is a technology that uses electrical power lines for the purpose of high speed transmission of data, video, voice etc. and working is facilitated through the transmission of high frequency signals through power cables distributing electricity to homes [10].

The concept of utilizing electrical networks for the purpose of broadband communication was introduced in the 1990s. The increasing research interest on the topic shows that PLS is the key to achieving broadband delivery specifically to low tele-density areas [11]. Since Power lines are generally provided to each house even in remote areas. In the context of developed countries, various options of broadband and telephony services are sometimes offered in costly prices. On the other hand, lack telecommunications infrastructure in developing countries. Therefore, it would be invaluable that countries use the power line for transmission of broadband [12]. At the same time, there is an important need for investigating and designing BPL deployment methodologies corresponding with electrical power components, since the performance of BPL is effected by the differences in electrical grid from country to another.

2. MCMC BPL GUIDELINES

Malaysian Communication and Multimedia Commission (MCMC) along with the Malaysian Technical Standard Forum Berhad (MTSFB) were created in 2005 in line with the guidelines stated in BPL communications. These guidelines worked as reference to establishing a clear comprehension of the basic requirement of facilitating potential BPL providers in providing their services. Members of MTSFB who expended efforts to create the contents of BPL guidelines were representatives hailing from telecommunication service providers, government related bodies, manufacturers, system developers, integrators and higher learning institutions such as, Celcom (Malaysia) Berhad, Corinex Global, Energy Commission, and Masers Digital Sdn. Bhd.

The summary of guidelines helps guide the introduction of BPL communications service by licensed service providers. It attempts to facilitate the understanding of the parties interested to provide this service in Malaysia. The guidelines encompass areas including:

- Compliance of the BPL system, the allowed operating frequency, the permitted operating power and equipment standards

- General requirement for operating BPL physical network layer that is applicable to Malaysia
- General requirement for deploying BPL physical network layer that is applicable to Malaysia and,
- Licensing

There is a dire need to examine power lines communication to bridge the digital divide through BPL networks as depicted in Figure 1, a proposed coordination between internet providers and electric provider network is depicted. This proposition is made in an attempt to achieve the Tenth Malaysian Plan 2011-2015, item 41 of 75% household internet access rate of penetration.

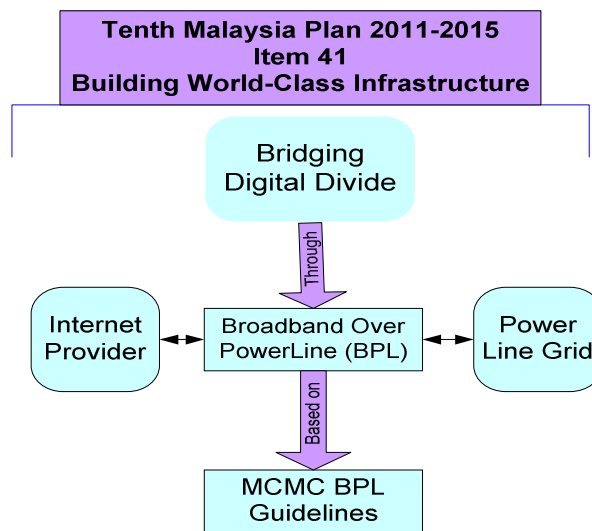

Figure 1. The Study General Bridging Digital Divide Model through BPL.

3. BPL PROPOSED MODEL

The system architecture comprises of backhaul data network connecting the BPL network to the telecommunications network and PBL network overlaying the electricity distribution network as described in (Figure 2).

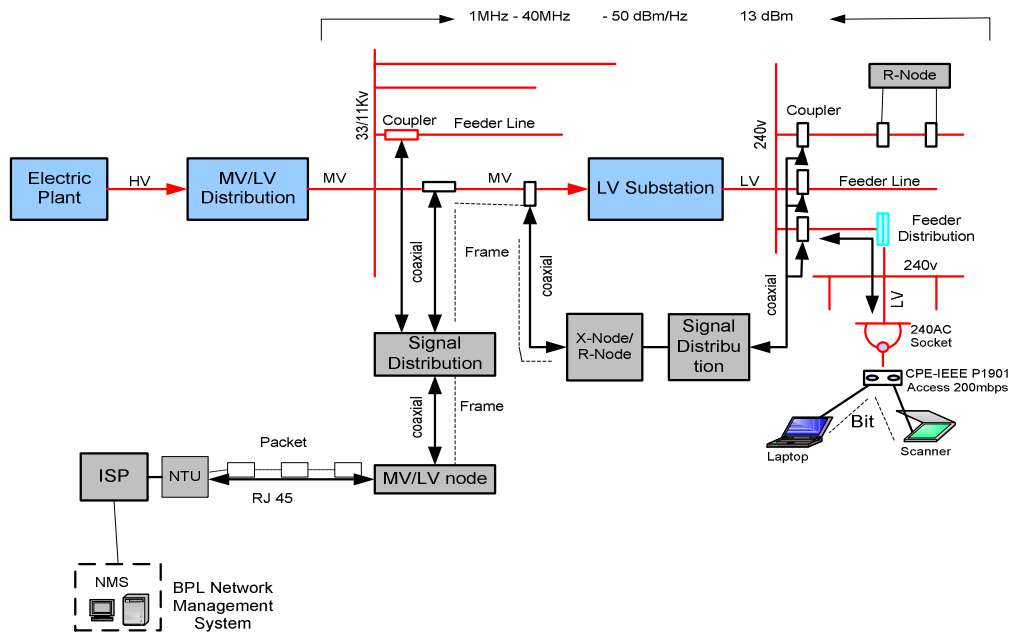

Figure 2. Broadband over PowerLines Model.

3.1 BPL Components

Many electronic devices or nodes are disseminated from various points in the electricity distribution network in order to overlay a communications network upon it. These devices are described as physical network layer elements that are developed to achieve particular tasks on the BPL network. On the basis of the guidelines stated in [13] and other research related to the topic, the list of electronic devices and their functions are described below:

Medium/Low Voltage Node (MV/LV-Node): it is a tool that converts normal IP-based communication signal to other suitable signal for transmission through power lines. It is capable of supporting various interfaces and functions like MV/LV Feeder line. Owing to safety reasons, the MV/LV-Node interface should not be directly connected to the power lines but through a coupling device either inductive or capacitive. The connection is made through a coaxial cable. In addition, a standard data interface ports (RJ-45) should be also used for connection to the telecommunications backhaul equipment. On the basis of the MCMC MV/LV-Node previously described the ML/LV node functions as an injector which is considered as a data transmitter and receiver, a signal convertor and distributor. The transmitter and receiver work on distinct frequencies, which in turn allow full duplex transmission over the power line. ML/LV-node transforms the signal from the RJ 45 to coaxial line into a signal format utilized for MV power line transmission. Generally, this action leads to the generation of Orthogonal Frequency Division Multiplexing (OFDM) signal comprising of a set of carriers that are modulated through the use of Binary Phase Shift Keying (BPSK) (held, 2006) or through the use of QPSK, QAM16, QAM64, etc. [14].

The Carrier Sense Multiple Access with Collision Avoidance (CSMA/CA) is considered as a network protocol having an MAC layer that is commonly used in IEEE 802.11 wireless LANs and by Apple's Local Talk wired LAN which is the network protocol used by most electric utility company equipment vendors. In addition, CSMA/CA is the access protocol used in most BPL systems for decreasing contention. It represents a version of Ethernet using collision avoidance as opposed to Ethernet collision detection tool owing to the unlimited distance between transmitting devices. It is also used for the improvement of the network's performance by its reservation to particular uses in a single device. In sum, the use of CSMA/CA is supported by features adding priority classes, control latency, and support quality system [15].

Transformer Nodes (X-Node and R-Node): The former is a device installed in the transformer room and it provides two main functions which are by-passing the transformer, and communicating signals between MV and LV lines coupled with being a repeater along the MV lines. The latter is a device that is implemented along the electric power lines and it provides greater reach on long lines or lines having high attenuation to maintain the end-to-end communication quality. Sometimes, the R-node is just a modified X-node meaning to say that they play as repeaters. BPL repeater is considered as a data generator which receives the digital signal, discards it, stabilizes and regenerates the signal to eliminate distortion because OFDM and other modulation methods lead to the transmission of analog signals and amplification. BPL repeater incorporates around every 1000 to 2500 ft along the MV power line [15]-[16].

Couplers facilitate the transmission and reception of communication signals from the electric power lines. There are two main ways for coupling the signal to the power line namely capacitive and inductive coupling depending on the system topology distribution [16]. The capacitive coupler is preferred for the overhead MV and LV lines in indoor applications and in distributions of Ethernet packets into the MV/LV frequency signals. On the other hand, the inductive coupler is preferred in overhead and underground. In order to couple the signal to the network's current waveform, an inductor is utilized. As they don't need physical connection to the network, they are safer to implement on energized lines compared to capacitive couplers [17]. Through the use of the coupler, data can be transmitted easily from the 7200 voltage line to the 240 voltage line into the house avoiding any degradation. In addition, couplers allow the both transmissions of the BPL signal and the power at the same time [18]-[19].

Line-conditioning is considered as a physical layer component device that is installed on MV and LV distribution lines and it passes or restricts signals on the basis of the predefined signals composition. Therefore, the line-conditioning device works as tool to subdivide or categorize the utility distribution network. Line-conditioning tools are basically installed close to utility devices to function as switches and capacitor banks [15].

Customer Premises Equipment (CPE) connects a BPL interface to the LV line, it stops and converts BPL signals to the normal IP based signals. CPE's construction should be modular to enable different interfaces for in-home services. These include support for in-home data network and telephony standard (RJ-11), analogue telephone ports [13].

The MCMC Public Consultation for Deployment of Power Line Communication System in Malaysia 2005, stated that in case the guidelines of BPL service has not followed the minimum interference level condition, then other standards are allowed to be considered. In addition the MCMC BPL guidelines also stated that the cases below go over the electric meter and it is not the power company's property. The BPL network deployment included in these circumstances is listed below.

3.2 BPL Requirement system in Malaysia

NIB (Non-Interference Basis): Operations of BPL should not cause any harmful interference to the radio transmission in any of the spectrum bands. The MCMC conducts regular testing to make sure that the radio emission standards are complied to prior to installing the service. In case of harmful interference, the transmission is ended until investigations are conducted and solution to the interference is applied.

Network Protocols: The BPL system should comprise of a Layer two network and it should be transparent for IP communications. It should also support duplex, broadcast and multicast communication efficiently.

Operating Frequency: The system installed in the MV and LV distribution system should work within the band frequency from 1 MHz to 40 MHz. The frequency utilized should not cause interference to other frequencies or reserved frequencies for the Government of Malaysia’s authorities, agencies and military frequencies or frequencies used by Malaysia’s neighboring countries. Frequencies that are over 40 MHz may be subject to technology development and deployment cases.

Operating Power: The system installed in the MV and LV system should be capable of limiting its output power to-50 dBm/Hz or less and the total output power should not be over 13 dBm. All the systems installed in the MV and LV should have features enhancing the service performance and reliability and inhibiting possible interference to other frequency users. These features should include frequency notching, frequency band blocking and power adjustment.

BPL system must have frequency notching, frequency band blocking and power adjustment. Which will enhance the service performance and reliability, and also to inhibit possible interferences to other frequencies users. MCMC focuses on electromagnetic compatibility; BPL system must work with surrounding equipment without effect their performance or causes any harm interference. The radiated emission limits for BPL installation should follow the Federal Communications Commission (FCC) Part 15 & 15.209 specified as in (Table 1) below:

Table 1. Radiated Emission Limits.

Frequency Bandwidth	Radiated emission limits
1 to 30 MHz 9KHz	30 μ V/m(29.59 dB μ V/m)at 30 meters
30 to 88 MHz 120KHz	100 μ V/m(40 dB μ V/m)at 3 meters

4. POWER LINE CHANNEL TRANSFER MODEL

For many years Power Line Communication (PLC) has been used for low bandwidth services. Recently, PLC technology has been improved in term of high speed data transmission, video, voice applications [20]. It is observed that power line network and its communication channel

has good chance for Broadband PLC technology. However, power line network was basically built for power transmission at 50-60Hz. means that, unlike to other communication channels. Therefore, to understand Broadband PLC, up to 30MHz frequency of the signal is used. Most thing must be in standard is power line channel model, since broadband PLC QoS is highly affected by its channel characteristics [21].

Power line channel transfer model is one of the most important elements in the Broadband PLC system technology. Several power line channel modeling methods are used. Such as multipath propagation environment [22] and power line channel using ABCD matrix theory [23]. Matrix theory represents the channel as two port transmission line. Figure 3 depicts a simple two transmission power line port. While power line is an unsteady transmission medium due to its time varying and channel reflections generated at the cable branches by impedance mismatch [24][25].

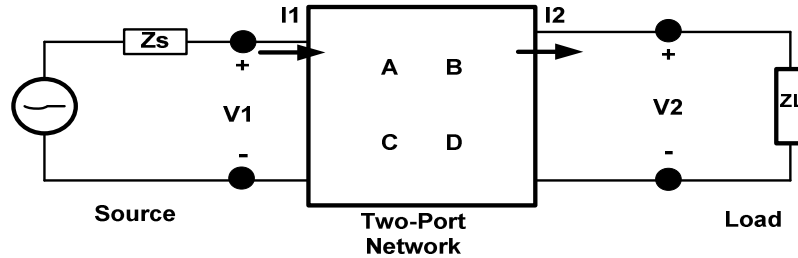

Figure 3. Simple Power Line Model.

Matlab/Simulink software is used in this paper which focuses on the modeling of LV Broadband PLC technology specifically, on its channel transfer function. The idea is to create the power line channel transfer function, with considering the LV scenario at a transmission band from 1 to 30 MHz. Matlab/Simulink software assumes the relative permittivity and permeability are uniform. The resistance (R), inductance (L), conductance (G), and capacitance (C) per unit length (meters) are as follows:

$$R = \frac{2}{a} \sqrt{\frac{\mu f}{\pi \sigma}}$$

$$C = \frac{\pi \epsilon}{\cosh^{-1}\left(\frac{d}{a}\right)}$$

$$L = \frac{\mu}{\pi} \cosh^{-1}\left(\frac{d}{a}\right) + \frac{R}{2\pi f}$$

$$G = 2\pi f C \tan \delta$$

Where:

- σ is conductivity in the conductor.
- μ is the permeability of the dielectric.
- ϵ is the permittivity of the dielectric.
- δ is the depth factor.

Figure 4 shows a two-wire transmission line. Its physical characteristics include the radius of the wires a diameter and d separation distance of power line.

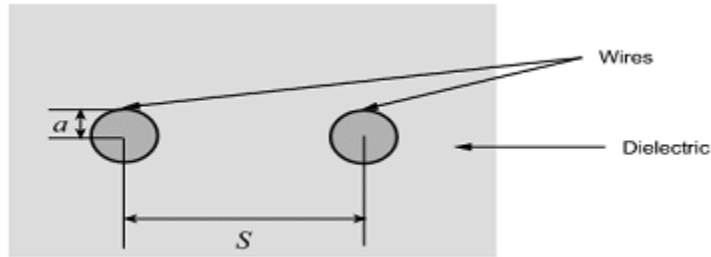

Figure 4. Two Wire Transmission Line.

Based on transmission line theory, the propagation constant γ and characteristic impedance Z_0 can be written as:

$$\gamma = \alpha + j\beta = \sqrt{(R + j\omega L)(G + j\omega C)}$$

$$Z_0 = \sqrt{\frac{R + j\omega L}{G + j\omega C}}$$

where parameter ω is the angular frequency. And real part α and the imaginary part β of the propagation constant are the attenuation constant and phase constant respectively. Typically, an indoor power line is composed of a main propagation path and several distributed branches [26][27].

4.1 Effect of Varying Length Model Analysis

Simulation was carried out used Matlab/Simulink to get the transfer function of whose frequency versus magnitude dB plot shows the attenuation in the signal strength and angle radian versus frequency plot gives the phase distortion or delay. We start the line length as equal to 10, 20m and 30m, simulate the network as power line network Ethernet carrier. Table 2 shows the line selected parameters for Simulation results.

Table 2. Line Parameters.

Parameter	Values
Wire radius	0.75e-4
Wire Separation	1.2e-3
Permeability constant	1
Permittivity constant	0.8
Conductivity of Conductor	58.5e6
Impedance	50 ohms
Frequency Injected	1e5:1.0e4:3e7

Consequence, in Figure 5, 6 and 7, show the deep notches at frequencies in the channel transfer function. A communication system between two access points or more, the carrier frequency injected must not present deep notches. Furthermore, as seen that the number of such notches is increased with the increment of line length.

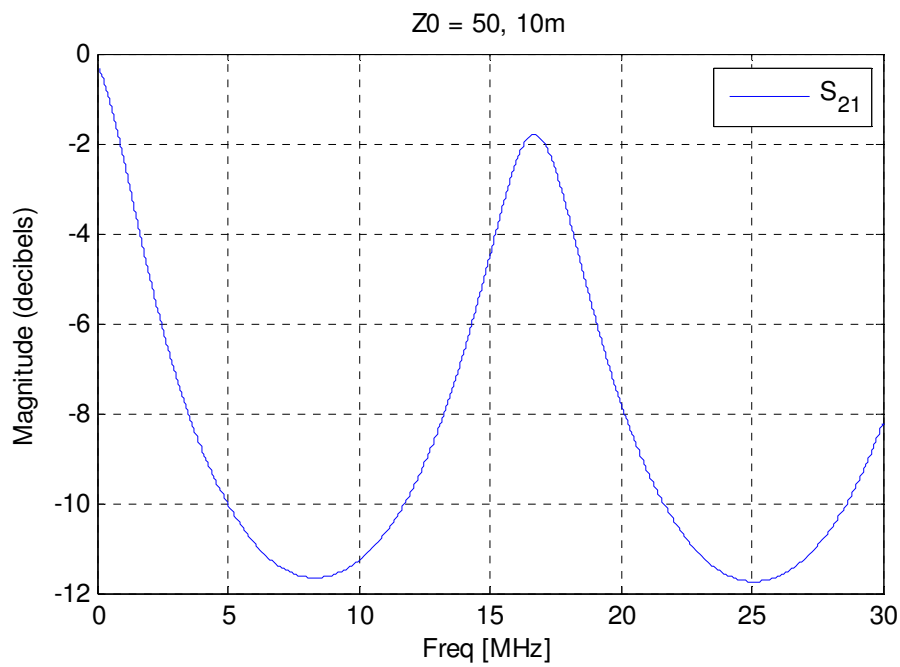

Figure 5. Magnitude of Transfer Function, Line Length 10m.

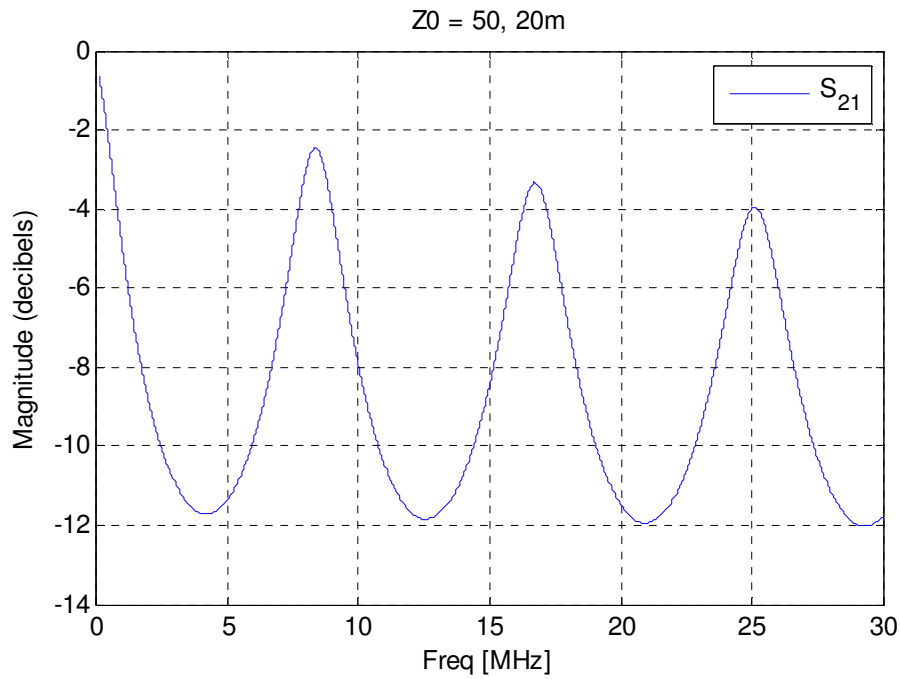

Figure 6. Magnitude of Transfer Function, Line Length 20m.

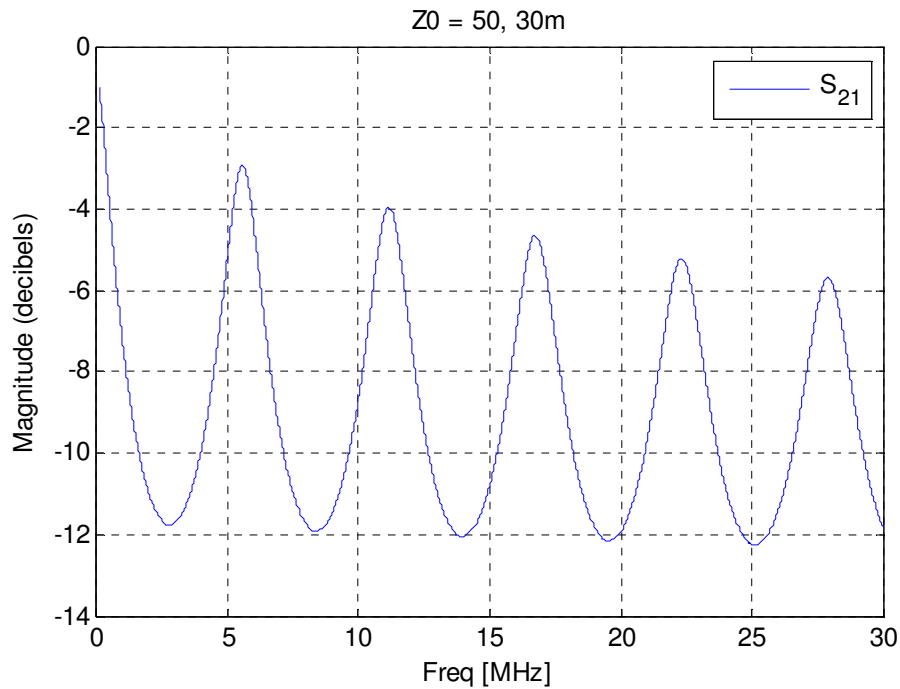

Figure 7. Magnitude of Transfer Function, Line Length 30m.

Also, Figure 8, 9 and 10 shows that there is deep notch with certain frequencies in the channel transfer function for example there is a discontinuity in the phase characteristics leading to delay or phase distortion. Once again, the increasing in the line length caused deep notches proportionally.

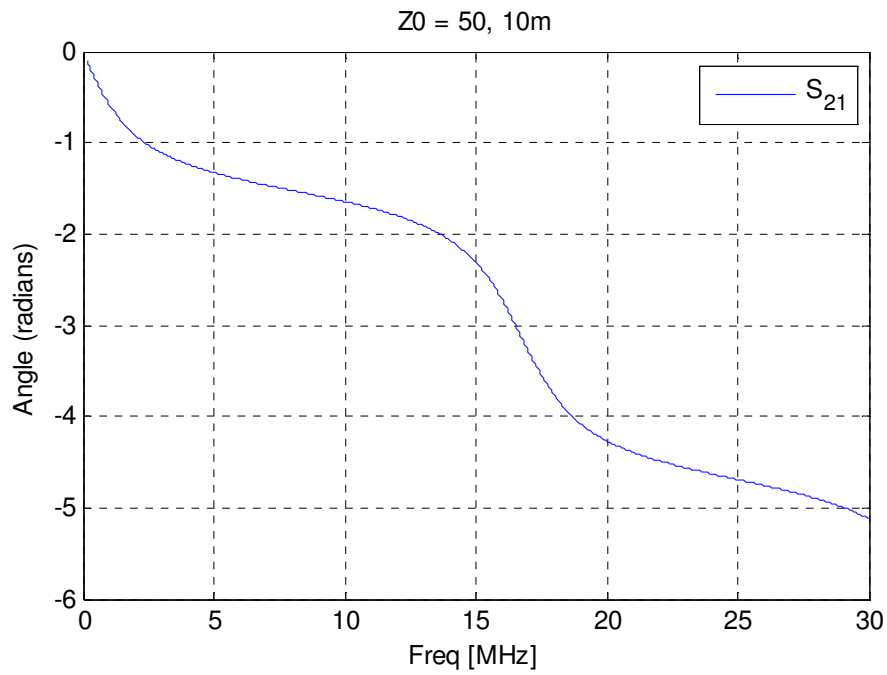

Figure 8. Phase of Transfer Function, Line Length 10m.

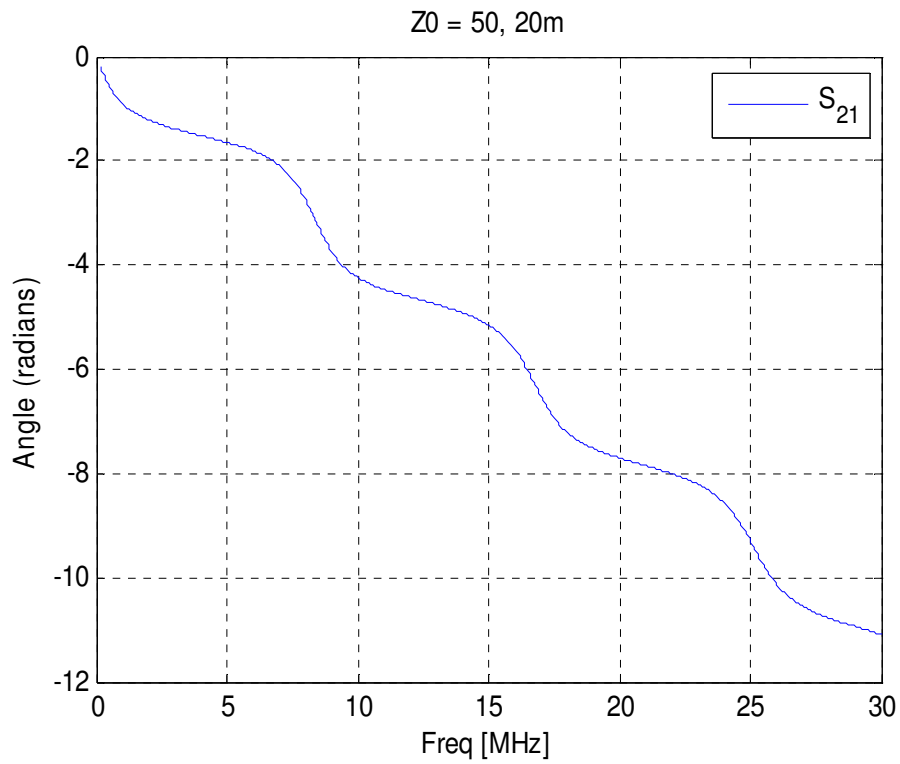

Figure 9. Phase of Transfer Function, Line Length 20m.

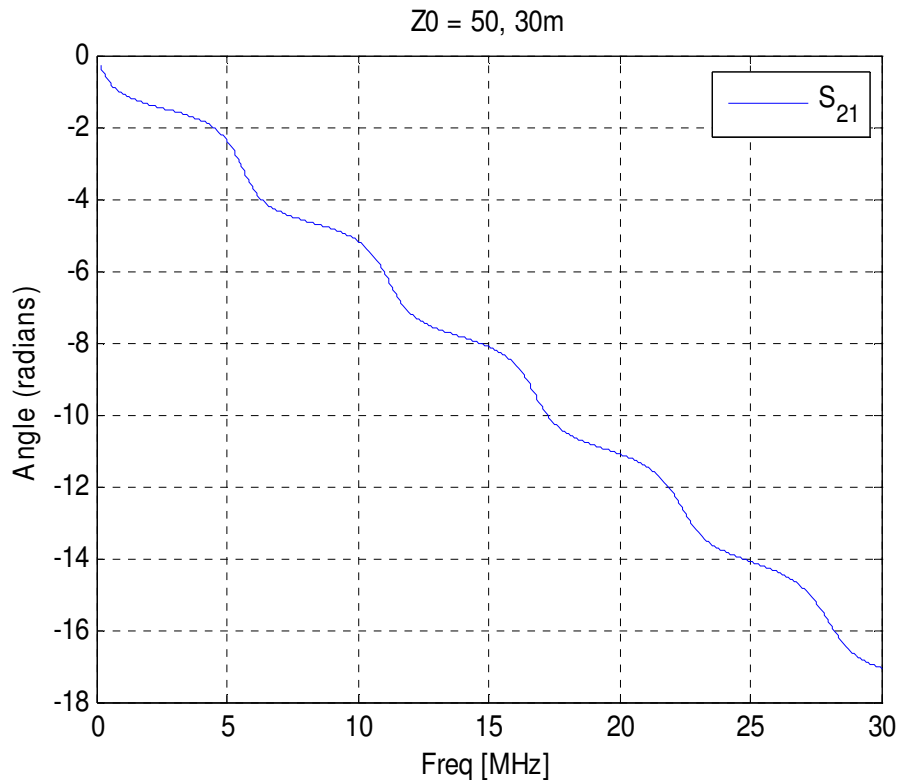

Figure 10. Phase of Transfer Function, Line Length 30m.

5. CONCLUSION

In this paper, the broadband initiatives stated in MCMC Malaysia, such as HSBB and Malaysia's National Broadband Implementation Strategy regarding the provision of high rate of household broadband penetration are summarized. While, Asia country report is noted that Malaysia stills in unsatisfied level of Internet access penetration. Therefore, this study is proposed the most potential solution by using the power line network as Ethernet carrier since power line is in every single house over the world. Broadband PLC model is constructed based on Malaysia regulations. By using Matlab/Simulink for inject Ethernet over power line with 1MHz to 30MHz as frequency of signals. The results of the simulation show that the increase of power line length is caused deep notches which represent attenuation over communication channel. In future work, more mathematical analysis has to spend in order to construct a standard for Low/Medium power line voltage channel transfer function model.

REFERENCES

- [1] Vajargah, F. K., & Jahani, S. (2009). Application of ICT in university curriculum development. *International Conference on Education Technology and Computer, IEEE*. 60-64.
- [2] Koonen, T. (2006). Fiber to the Home/Fiber to the Premises: What, Where, and When?. *Proc. Of the IEEE, 94*, 911-934.

- [3] Riding, J., Ellershaw, J., Tran, A., Guan, L., & Smith, T. (2009). Economics of broadband access technologies for rural areas. *Optical Fiber Communication OFC Conference*, IEEE, 1-3, 22-26.
- [4] Jusoff, K., Hassan, Z., & Razak, N. (2010). Bridging the digital divide: An analysis of the training program at Malaysian telecenters. In *Proceeding for International Conference on Applied and Theoretical Mechanics*, WSEAS, 2010. Held on December 29-31 2010. At Universiti Kebangsaan Malaysia Selangor. pp 15-23. Malaysia: SciVerse.
- [5] Ibrahim, Z., & Ainin, S. (2009). The Influence of Malaysian Telecenters on Community Building. *Electronic Journal of e-Government*, 7(1), 77 - 86.
- [6] Hassan, S. (2011). The Malaysian public sector ICT strategic plan. Retrieved January 29, 2011 from <http://www.mampu.gov.my/pdf/flipbook/ISPplan2011>
- [7] Suruhanjaya Komunikasi & Multimedia Malaysia. (2010). National broadband initiative (nbi): high-speed broadband project (hsbb) and broadband for general population (bgpp). Retrieved January 29, 2011 from http://www.itu.int/ITU-D/asp/CMS/Events/2010/ITU-ADB/Malaysia/S1-Mr_Ahmad_Hozir_Amir_Hamzah.pdf
- [8] Clark, M., & Gomez, R. (2011). Cost and other barriers to public access computing in developing countries. *Proceedings of the 2011 Iconference*, Washington, 08 - 11 February 2011 (pp.181-188). Washington, USA: Seattle University.
- [9] Malaysia Equity Research. (2011). Sector focus telecommunications. Retrieved January 25, 2012 from <http://www.einvest.com.my/ArchiveCompanyFocus/2.%20Sector%20Focus/2011%20Sector%20Focus/Telco%2020110106%20Update.pdf>
- [10] Qiu, X. (2007). Powerful talk. *IEEE Power Engineer*, 21(1), 38-43.
- [11] Tinarwo, L. (2008). *Development of methodologies for deploying and implementing local & medium area broadband plc networks in office and residential electric grids*. Master. Thesis, Computer Science, University of Forte Hare: Alice, Eastern Cape, South Africa.
- [12] Ma, Y., So, P., & Gunawan, E. (2005). Performance analysis of OFDM systems for broadband power line communications under impulsive noise and multipath effects. *Power Delivery*, IEEE, 20(2), 674- 682.
- [13] Malaysian Communications and Multimedia Commission. (2005). Guidelines on broadband over power line communications. Retrieved November 20, 2011 from http://www.kpkk.gov.my/akta_kpkk/Guidelines%20BPL-Sep05.pdf
- [14] Ray, P.K., Hazra, A., Basu, S., Mitra, S.K., & Roy, S. (2011). Broadband powerline communication an Indian experience. *Power Line Communications and Its Applications (ISPLC), IEEE International Symposium*, 364-369.
- [15] Held, G. (2006). *Understanding broadband over power line*. Auebach Publications, Taylor and Francis Group LCC, New York: United State.
- [16] Lushbaugh, L., & Safavian, R, S. (2007). Broadband over power lines (bpl). *Bechtel Telecommun Technical*, 5(1), 19-38.
- [17] Yang, Y, J., & Arteaga, C, M. (2009). Broadband over powerline field trial for commercial in-building application in a multi-dwelling-unit environment. *Power Line Communications and Its Applications, ISPLC, IEEE International Symposium*, 342-346.
- [18] Valdes, R. (2011). How broadband over powerlines works. Retrieved October 27, 2011, from <http://computer.howstuffworks.com/bpl3.htm>
- [19] Sarafi, A., Tsiropoulos, G., & Cottis, P. (2009). Hybrid wireless-broadband over power lines: A promising broadband solution in rural areas. *Communications Magazine, IEEE* , 47(11), 140-147.

- International Journal of Computer Networks & Communications (IJCNC) Vol.4, No.5, September 2012
- [20] Huangqiang, L., Sun, Y., & Yao, Y. (2008). The indoor power line channel model based on two-port network theory. *Signal Processing, 9th International ICSP*, 132-135, 26-29.
- [21] Mlynek, P., Koutny, M., & Misurec, J. (2010). Power line modelling for creating PLC communication system. *International Journal Of Communications, 1(4)*, 13-21.
- [22] Dostert, Z. (2002). A Multipath Model for Powerline Channel. *IEEE Transactions on Communications, 50(4)*, 553-559.
- [23] Mlynek, P., Misurec, J., Koutny, M., & Orgon, M. (2011). Power Line Cable Transfer Function for Modelling of Power Line Communication System. *Journal of Electrical Engineering, 62(2)*, 104-108.
- [24] Khan, S., Salami, F., Lawal, A., AHM Zahirul Alam, Hameed, A., & Salami, E. (2008). Characterization of Indoor Power lines As Data Communication Channels Experimental Details and Results. *World Academy of Science, Engineering and Technology*, 624-629.
- [25] Mario, M. (2012). Power line communication system modeling based on coded OFDM. MIPRO, Proceedings of the 35th International Convention, IEEE, 760-764.
- [26] Arora, S., Chandna, K, V., & Thomas, S. (2011). Modeling of broadband indoor power line channel for various network topologies. *IEEE PES Innovative Smart Grid Technologies*, 229-235.
- [27] Rashidi, M., Kalantar, M., Hosseinzadeh, S., Samsunchi, N., & Kazemi, A. (2011). Modeling of line parameters for the broadband power line carrier channel. *International Journal on Technical and Physical Problems of Engineering, 3(4)*, 132-13.

Authors

Abdallah Mahmoud Received B.S. in Computer Information System at Mutah University, Jordan in 2009 and obtained his M.S degree in 2011 from University Utara Malaysia (UUM). He is currently a Ph.D. student in the School of Computing at UUM. His research interests include the Broadband over Power Line Communication QoS.



Assoc. Prof. Dr. Wan Rozaini Sheik Osman is the Director of ITU-UUM ASP CoE for Rural ICT Development. Prof. Dr. Wan received his first degree Bachelor in Physic, Universiti Sains Malaysia, 1982. Advance Diploma, Systems Analysis for the Public Sector, the University Of Aston in Birmingham, United Kingdom, 1983. Master, Operational Research And Systems Analysis, The University Of Aston In Birmingham, United Kingdom, 1985 and her PhD in Computer Science, University Of Salford, United Kingdom, 1996.



Dr. Kashif Nisar received his first degree Bachelor in Computer Science from Karachi, Pakistan and his MS degree in Information Technology from the Universiti Utara Malaysia (UUM). He received his PhD degree in Computer Networks (specializing in WLANs, VoIP, IPv6 and he proposed a novel Voice Priority Queue (VPQ) scheduling system model) from the Universiti Teknologi PETRONAS (UTP) in the Malaysia.

